



 **LORENZOLINE**

100WP

Wall Partition System | Ofis Bölme Sistemi

100WP

WALL PARTITION SYSTEM OFİS BÖLME SİSTEMİ

- Assembly can be done in a short time, thanks to most of the manufacturing can be done in the workshop.
- It offers quick installation thanks to the mounting of the panels with clips.
- It is compatible with all doors of the 24D system.
- Thanks to the corner turning profile, different office types can be created.
- Venetian blind can be installed if desired.

- İmalatın çoğunun atölyede yapılabilmesi ile kısa sürede montaj yapılabilir.
- Panellerin klips ile montajı sayesinde hızlı montaj imkanı sunar.
- 24D sisteminin tüm kapılarıyla uyumludur.
- Köşe dönüş profili sayesinde farklı ofis tipleri oluşturulabilir.
- İstenildiğinde jaluzi konulabilir.

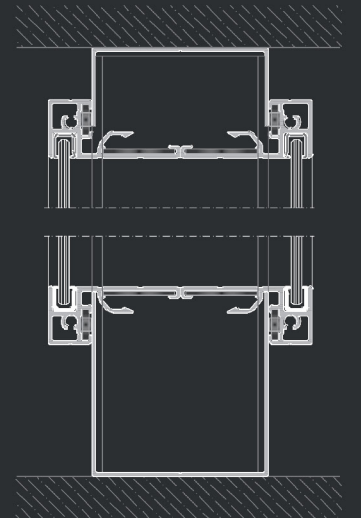
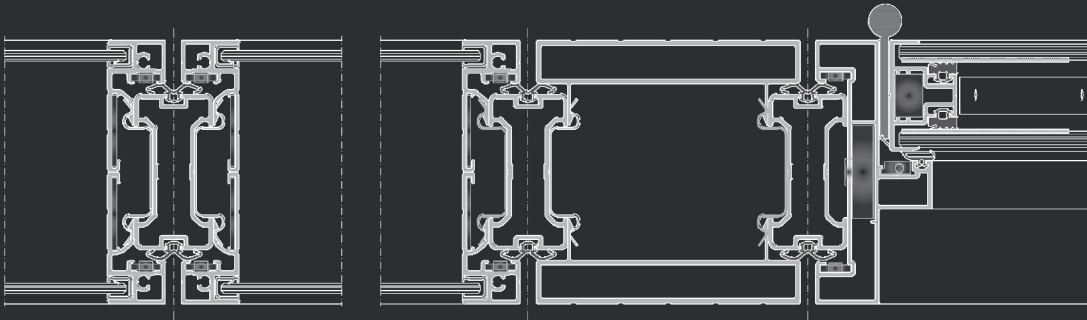

PROFILES
PROFILLER

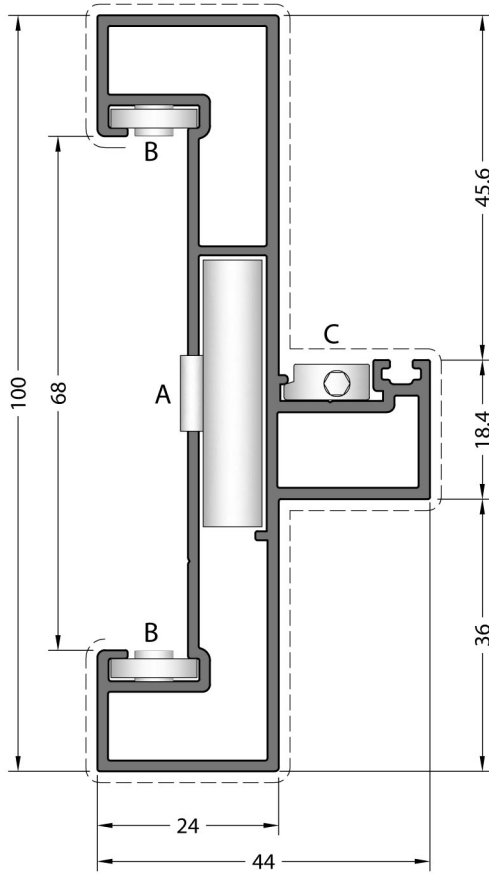

CODE / KOD

100WP-101-00

THEORETICAL WEIGHT

TEORİK AĞIRLIK (kg/m)

1.403



A LC-0936



B MK100WP-202



C LC-122

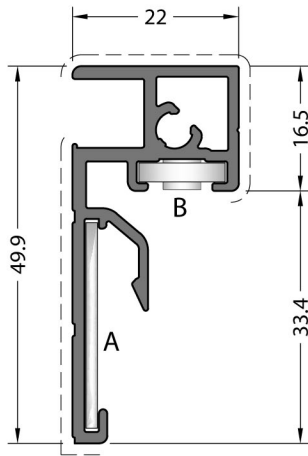

CODE / KOD

100WP-201-00

THEORETICAL WEIGHT

TEORİK AĞIRLIK (kg/m)

0.578

CORNER JOINT

KÖŞE BAĞLANTI



A 14-119-015
(27.2 mm)



B MK100WP-202

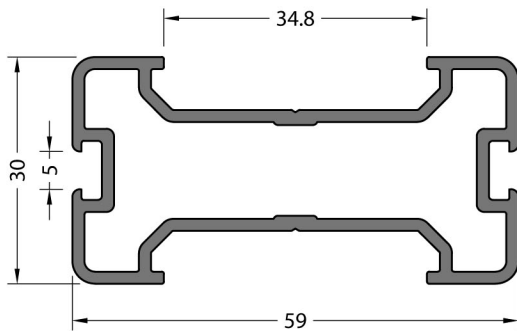

No visible surface.

Görünen yüzeyi yoktur.

CODE / KOD

100WP-301-00

THEORETICAL WEIGHT

TEORİK AĞIRLIK (kg/m)

0.933

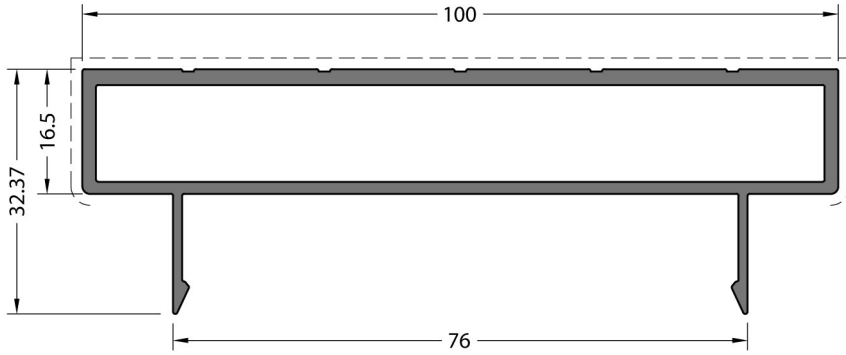

CODE / KOD

100WP-401-00

THEORETICAL WEIGHT
TEORİK AĞIRLIK (kg/m)

1.224

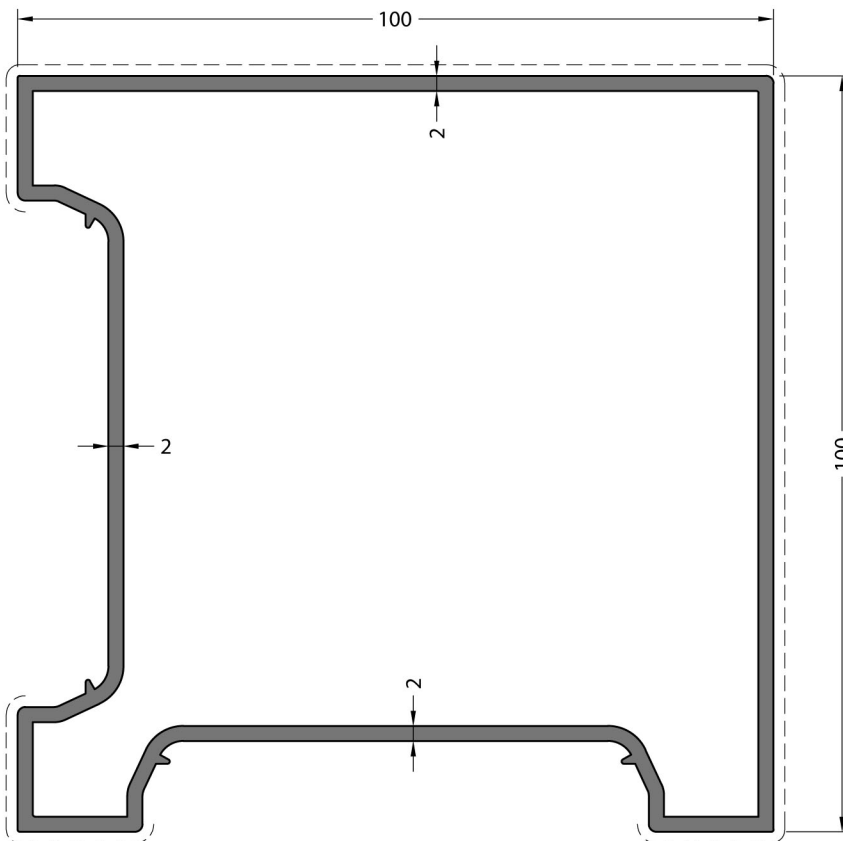

CODE / KOD

100WP-501-00

THEORETICAL WEIGHT
TEORİK AĞIRLIK (kg/m)

2.314

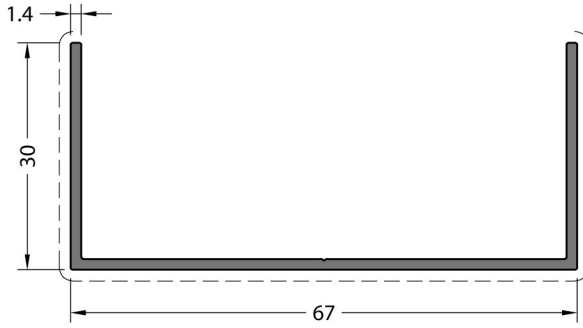

CODE / KOD

15-194-014

THEORETICAL WEIGHT
TEORİK AĞIRLIK (kg/m)

0.469

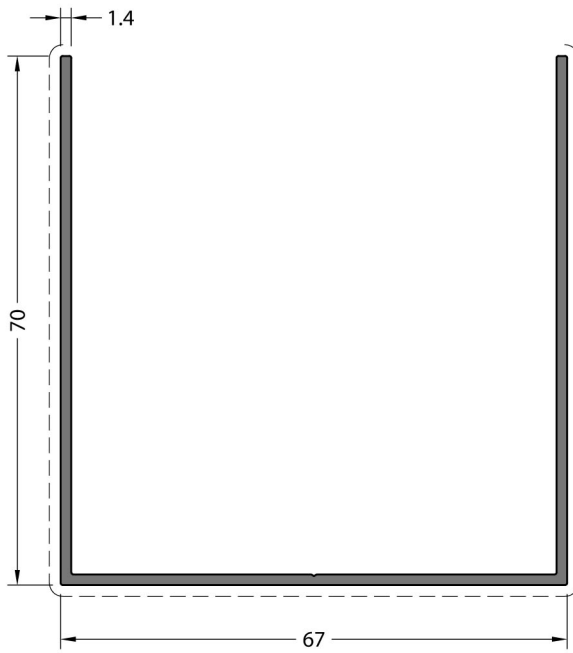

CODE / KOD

15-195-014

THEORETICAL WEIGHT
TEORİK AĞIRLIK (kg/m)

0.771

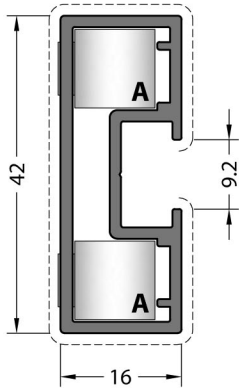

CODE / KOD

24D-271-00

THEORETICAL WEIGHT

TEORİK AĞIRLIK (kg/m)

0.552

CORNER JOINT

KÖŞE BAĞLANTI



A KC-801-10.5
(27.2 mm)

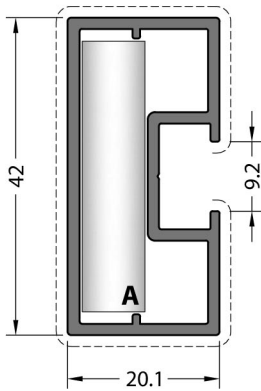

CODE / KOD

24D-272-00

THEORETICAL WEIGHT

TEORİK AĞIRLIK (kg/m)

0.574

CORNER JOINT

KÖŞE BAĞLANTI



A LC-0936

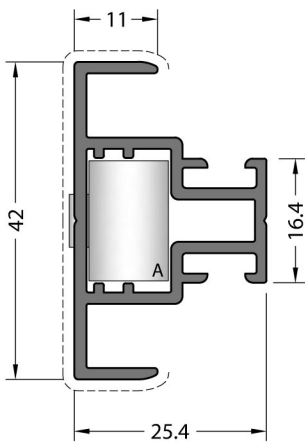

CODE / KOD

24D-261-00

THEORETICAL WEIGHT

TEORİK AĞIRLIK (kg/m)

0.594

CORNER JOINT

KÖŞE BAĞLANTI



A CC-101-16.0

MECHANICAL CORNER JOINT

MEKANİK KÖŞE BAĞLANTI



A KC-801-16.0

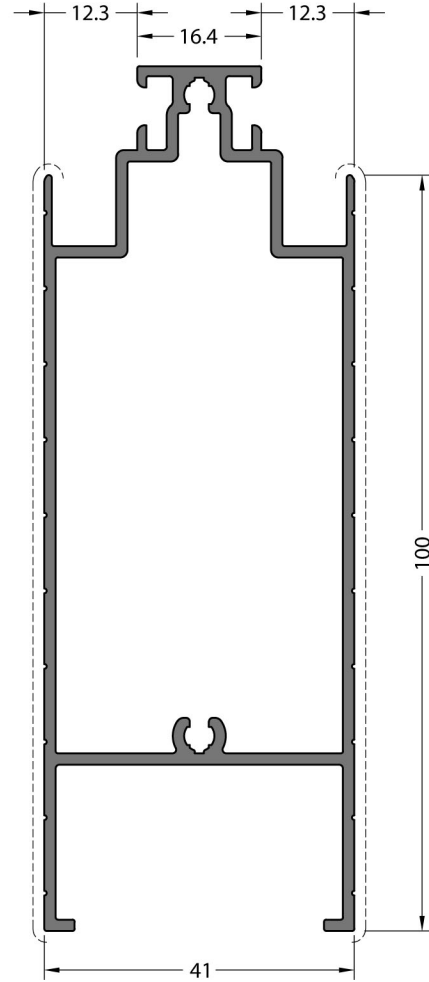

CODE / KOD

24D-262-00

THEORETICAL WEIGHT

TEORİK AĞIRLIK (kg/m)

1.410

DETAILS
DETAYLAR

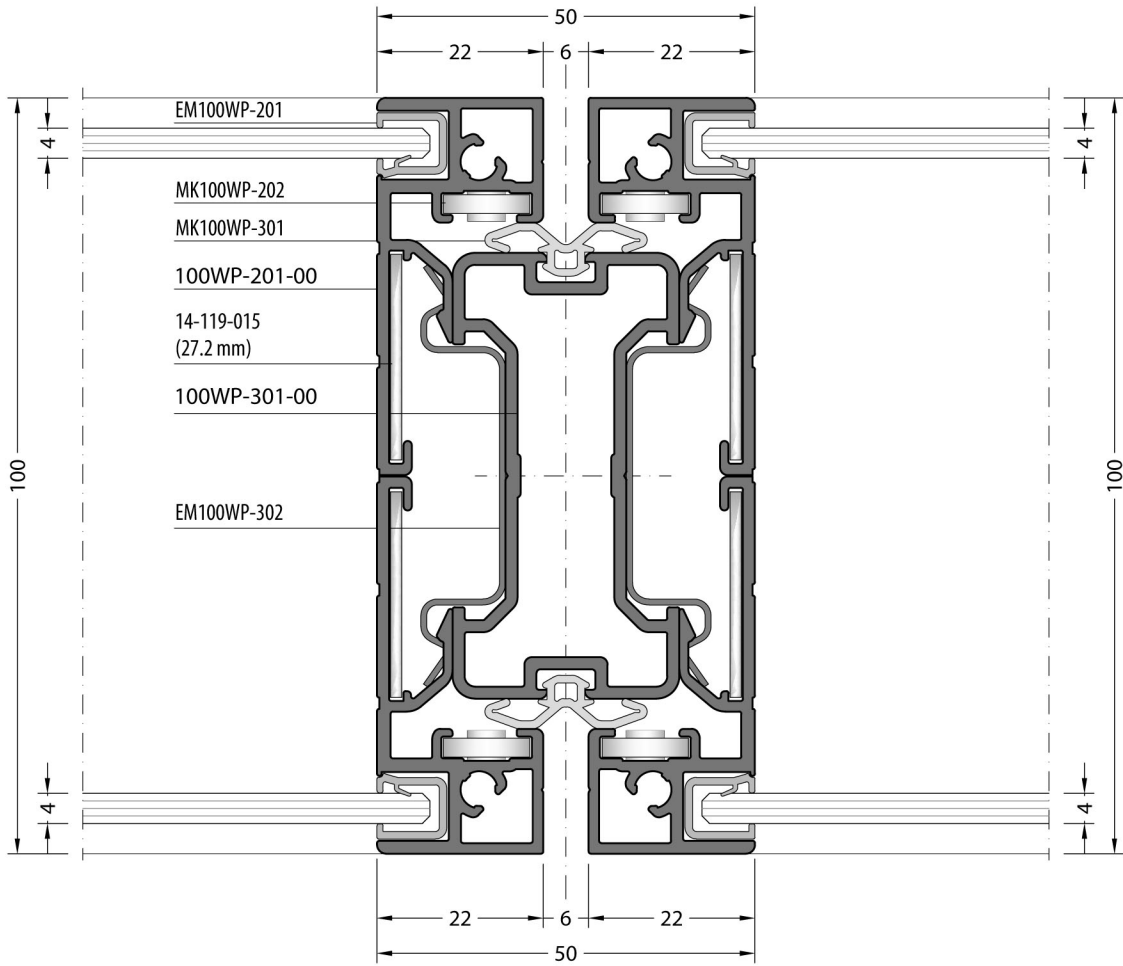
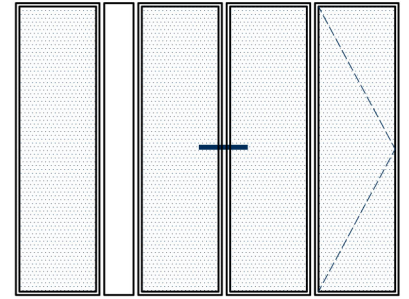

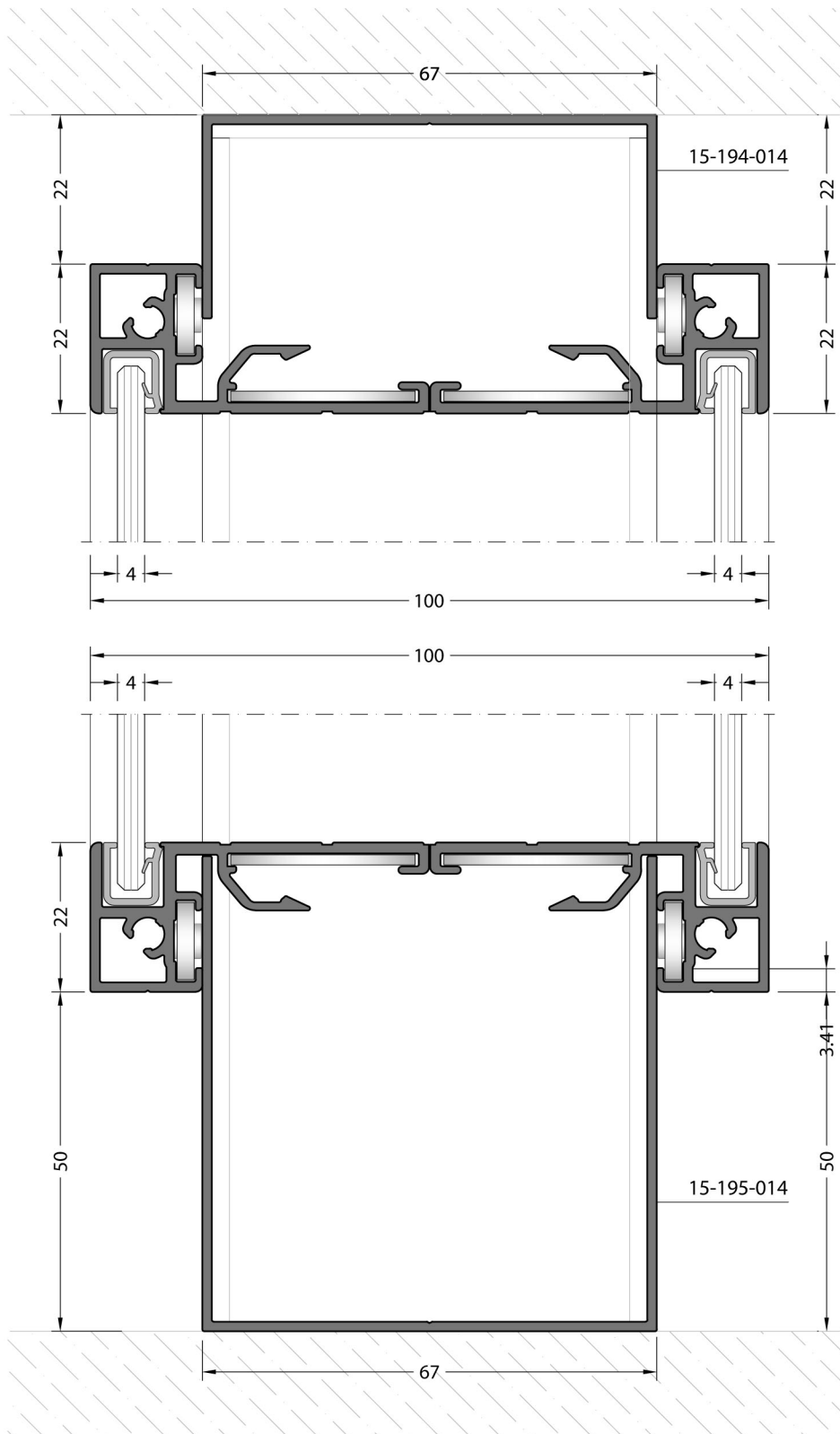
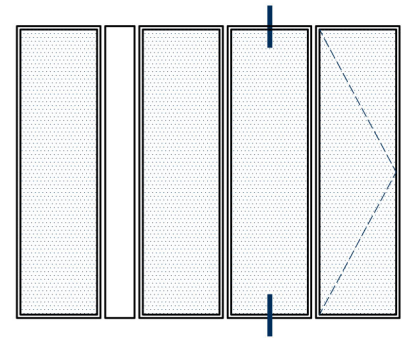

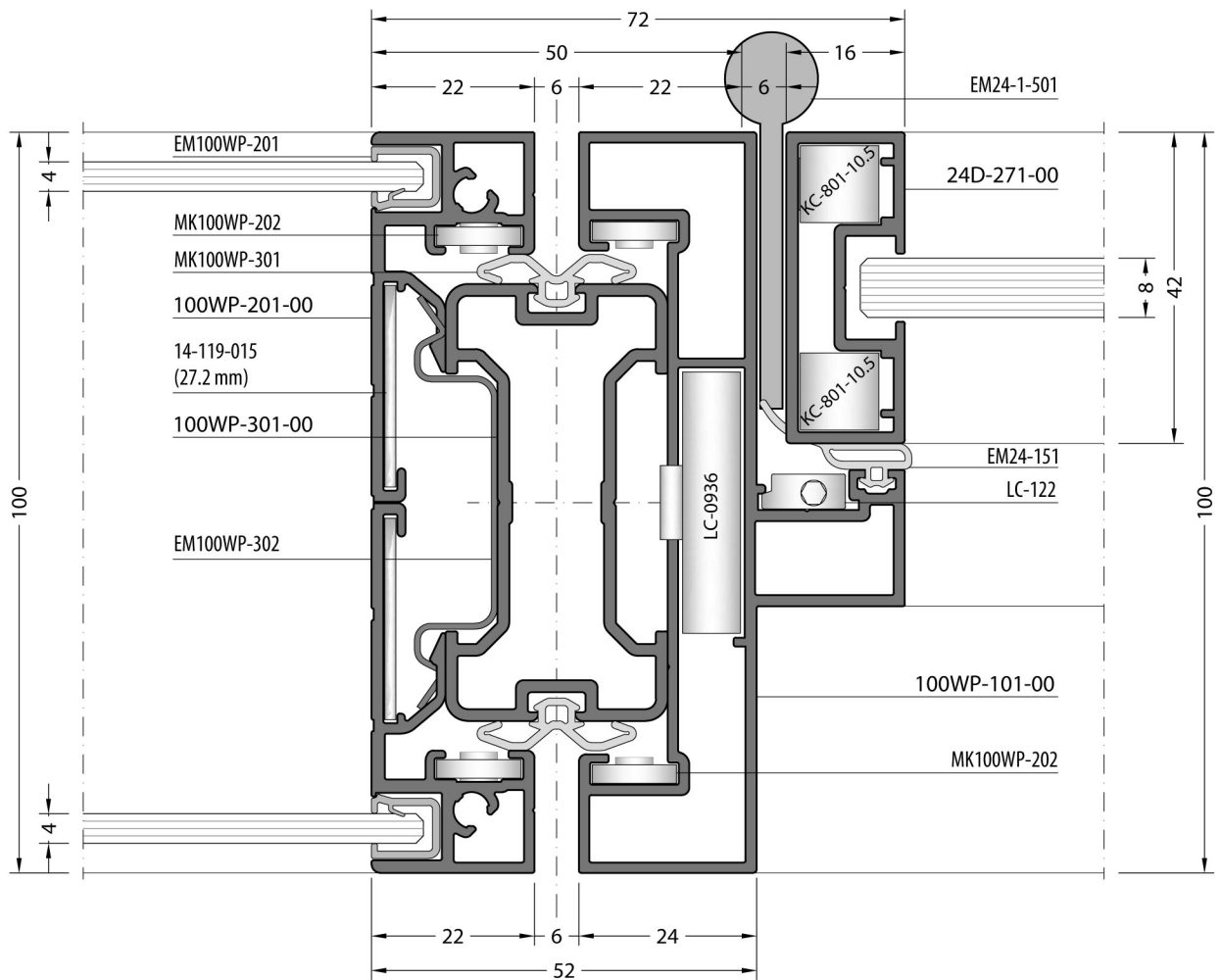
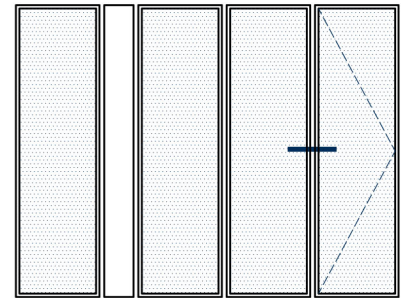

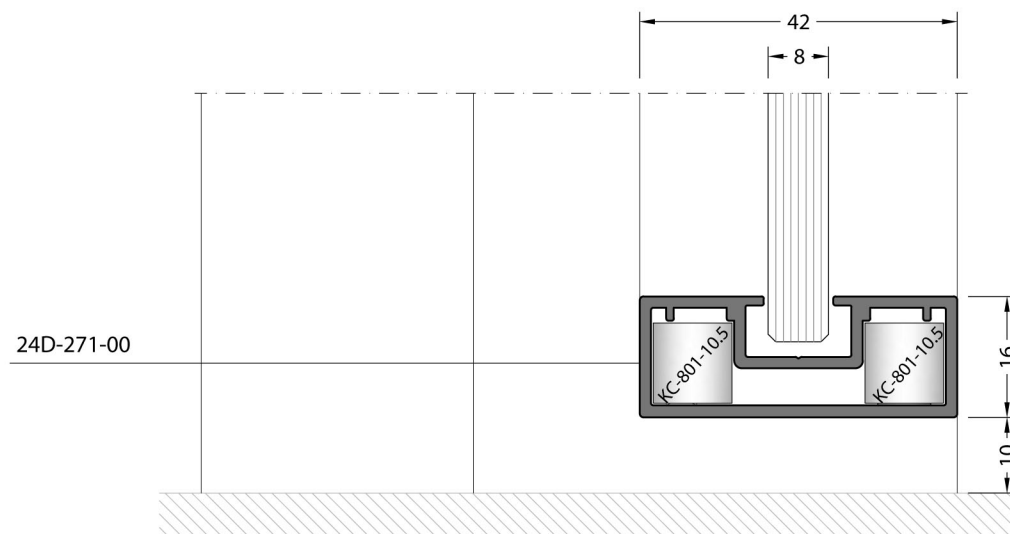
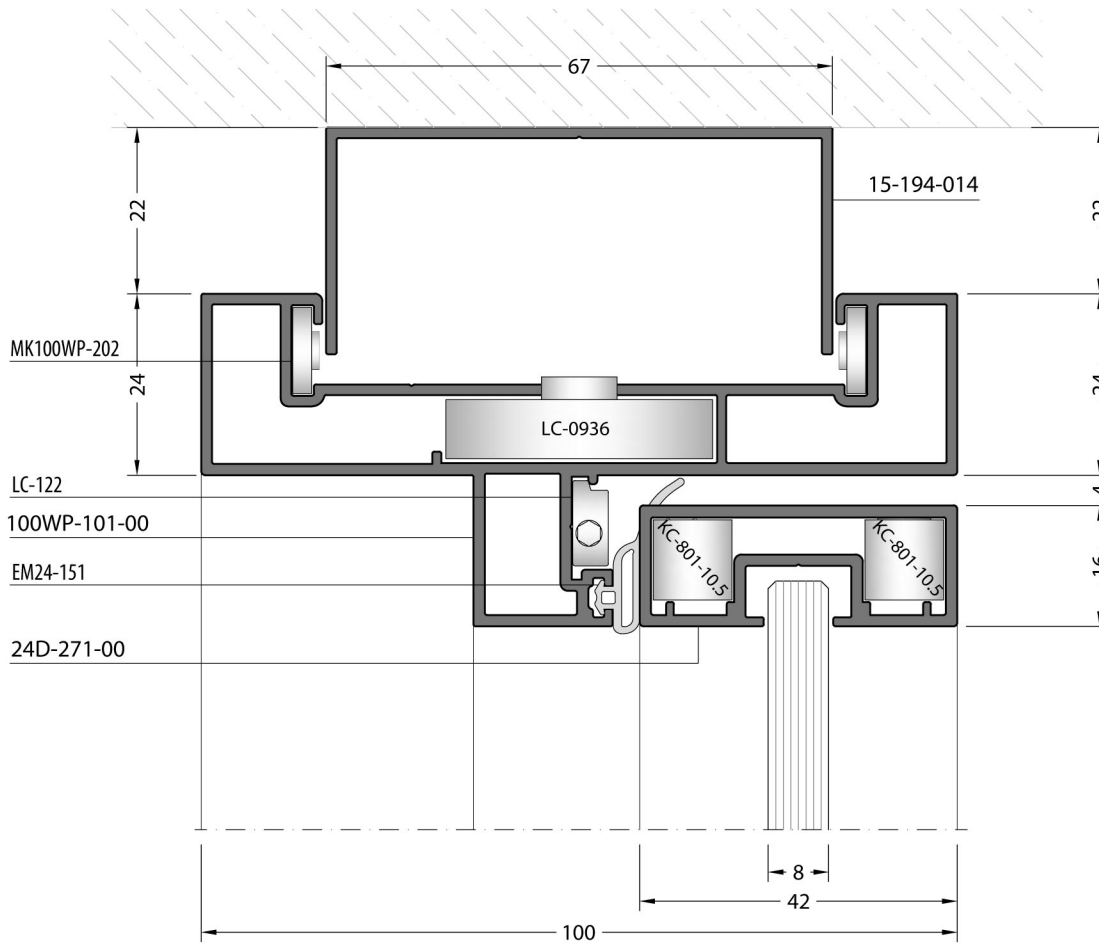
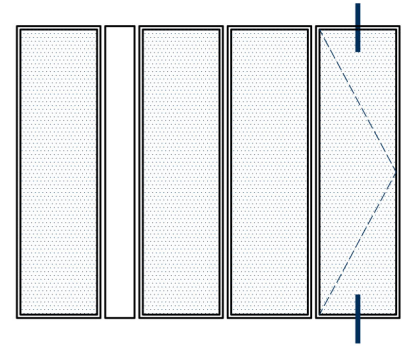

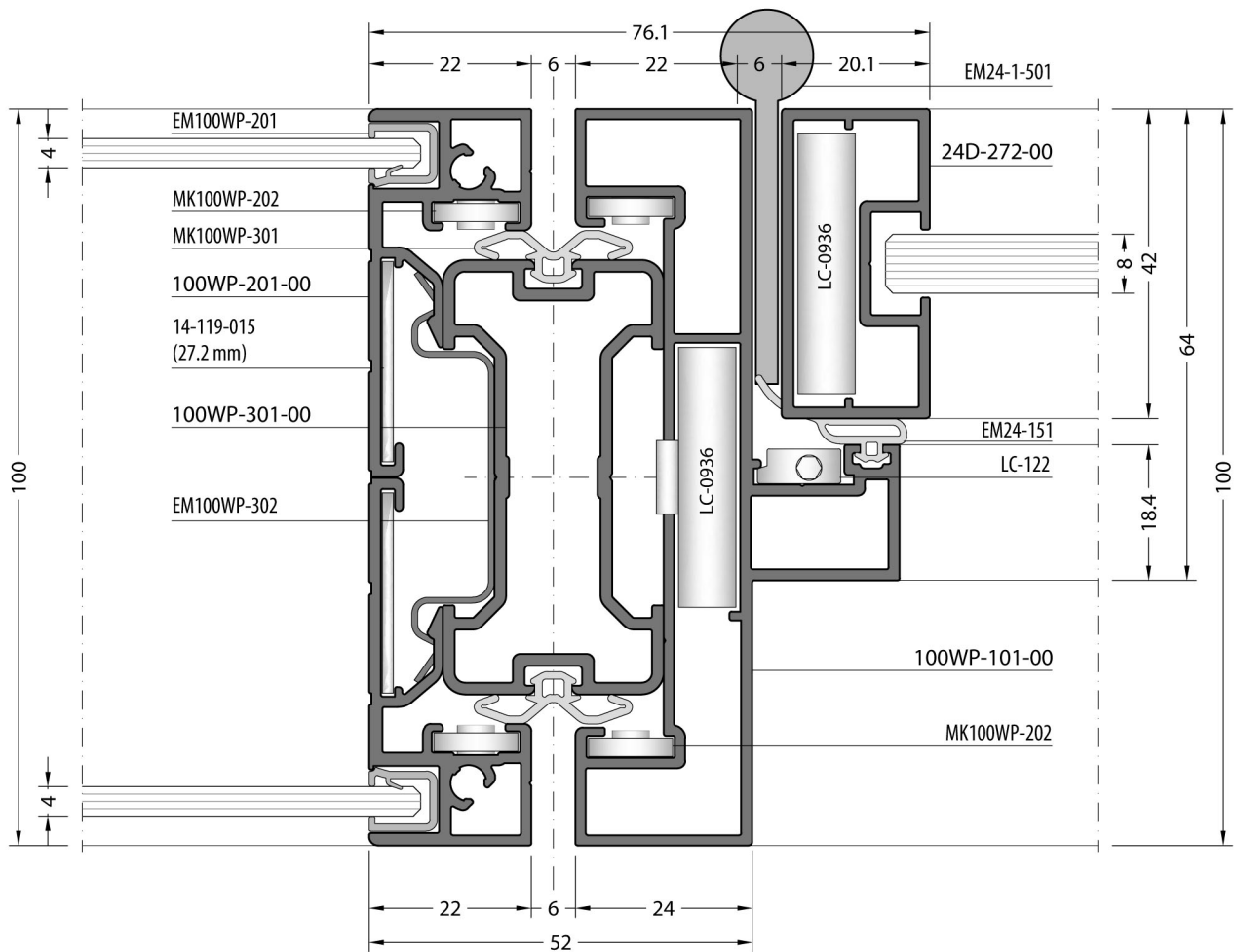
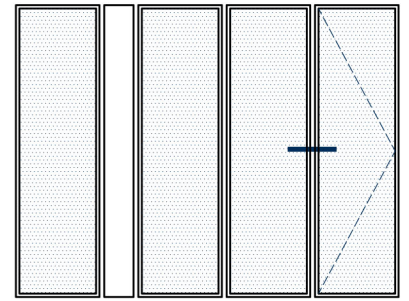

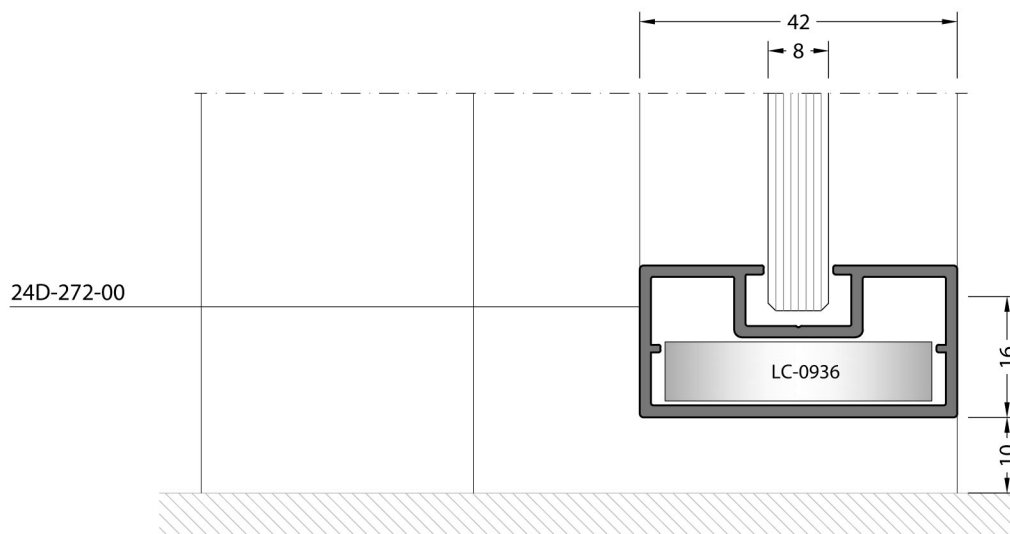
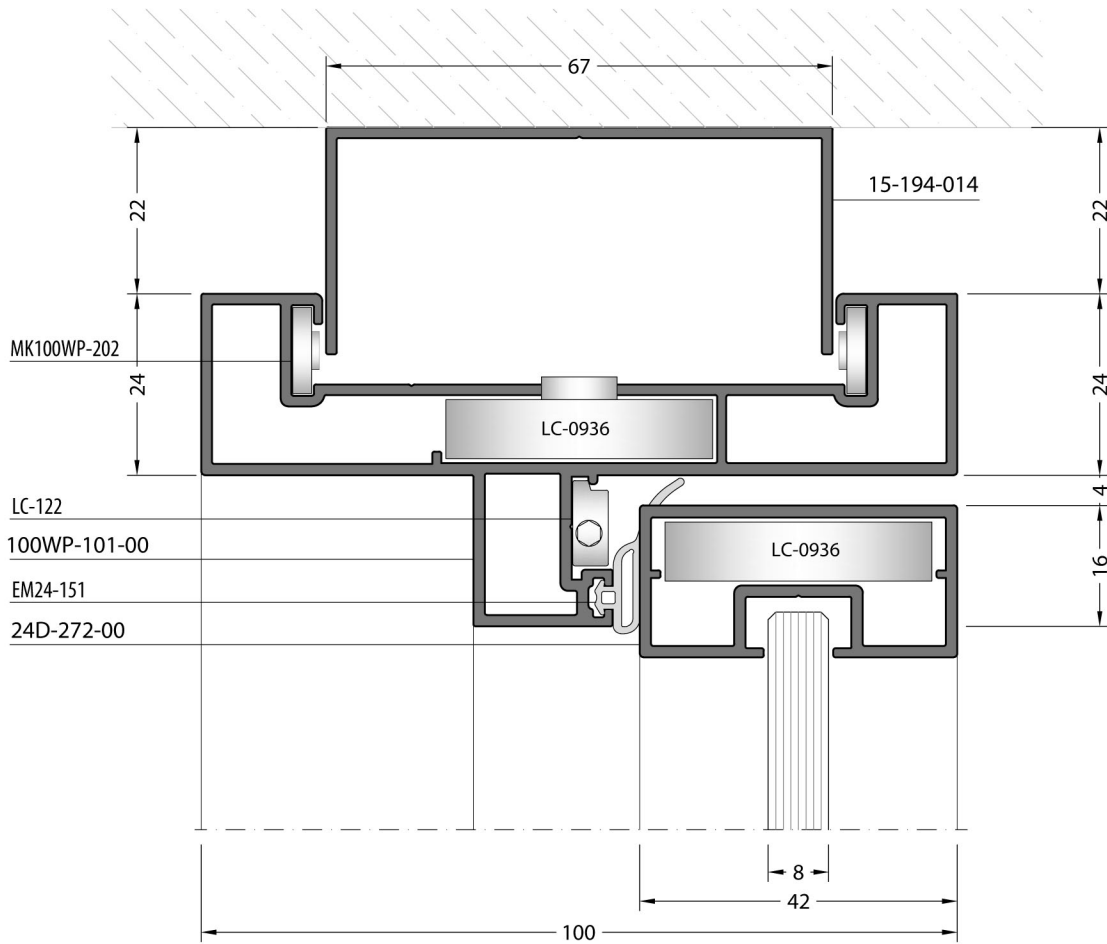
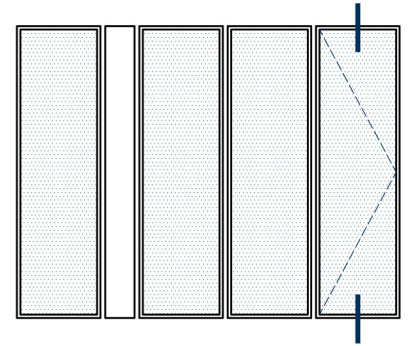

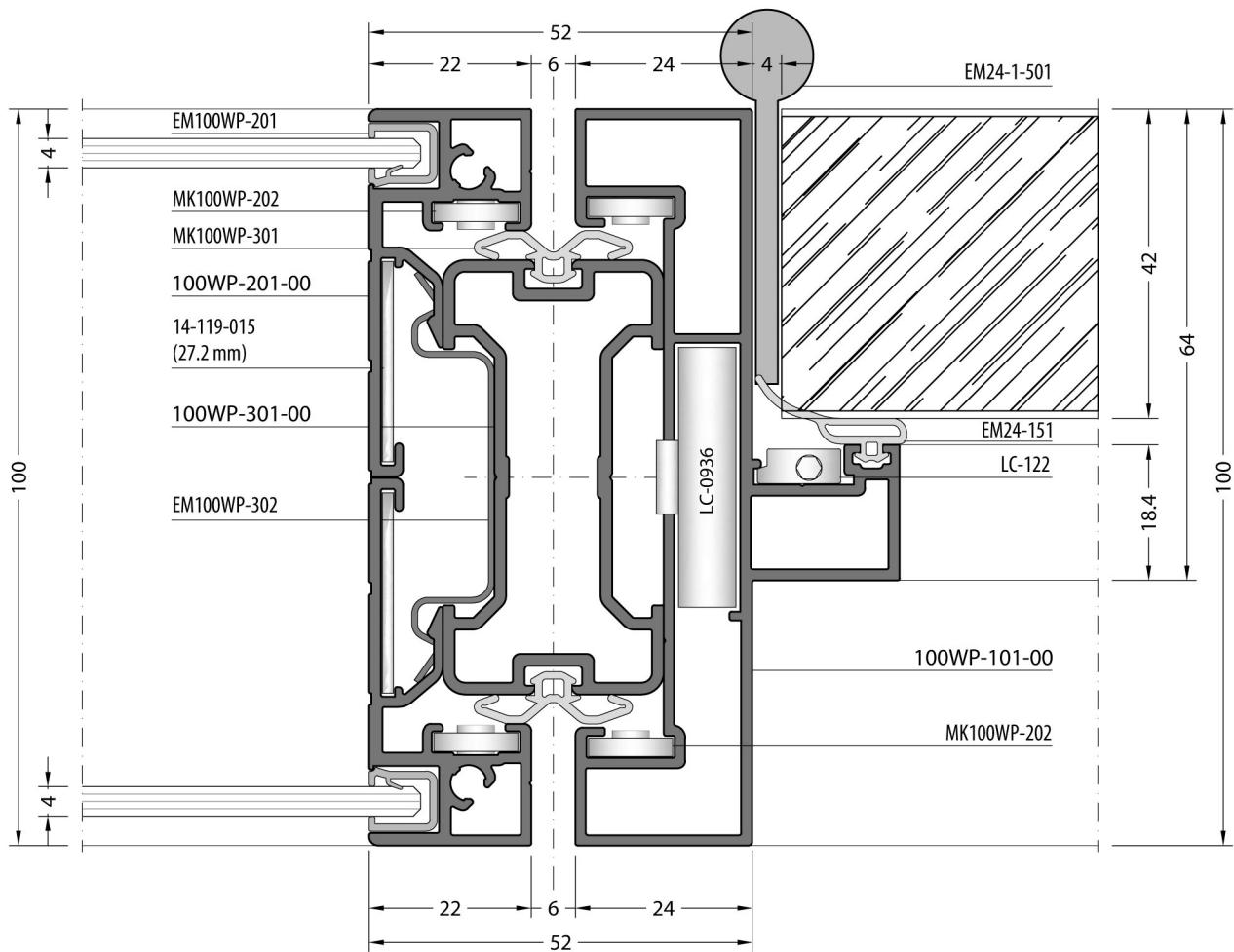
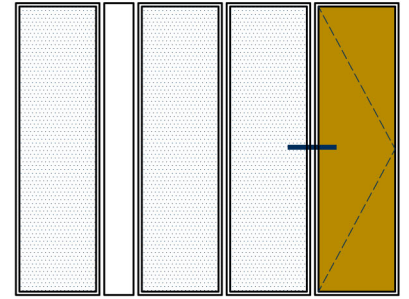

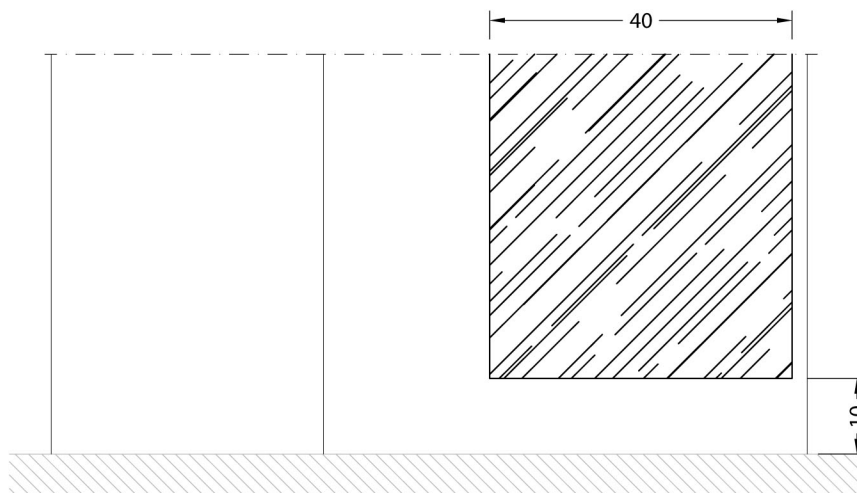
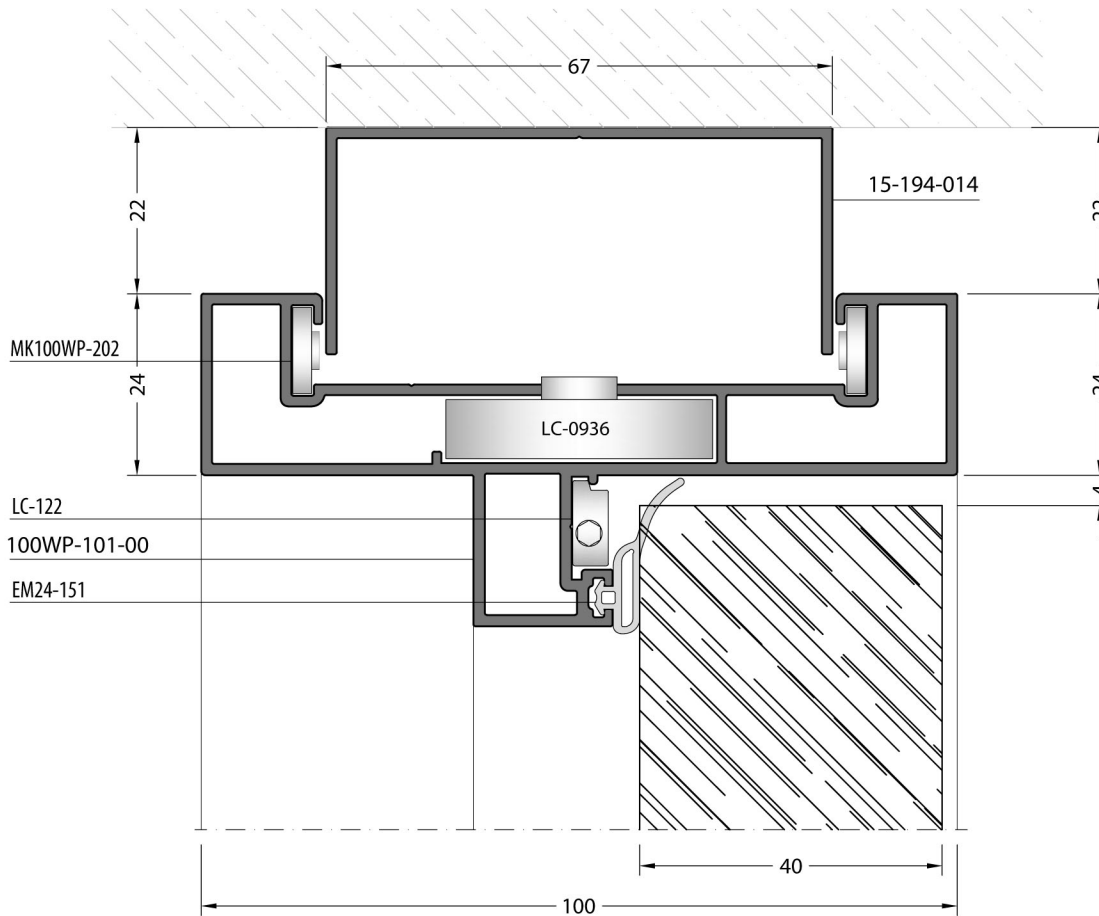
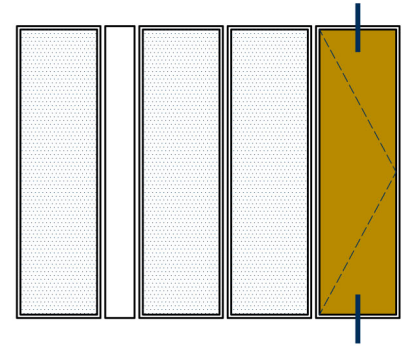

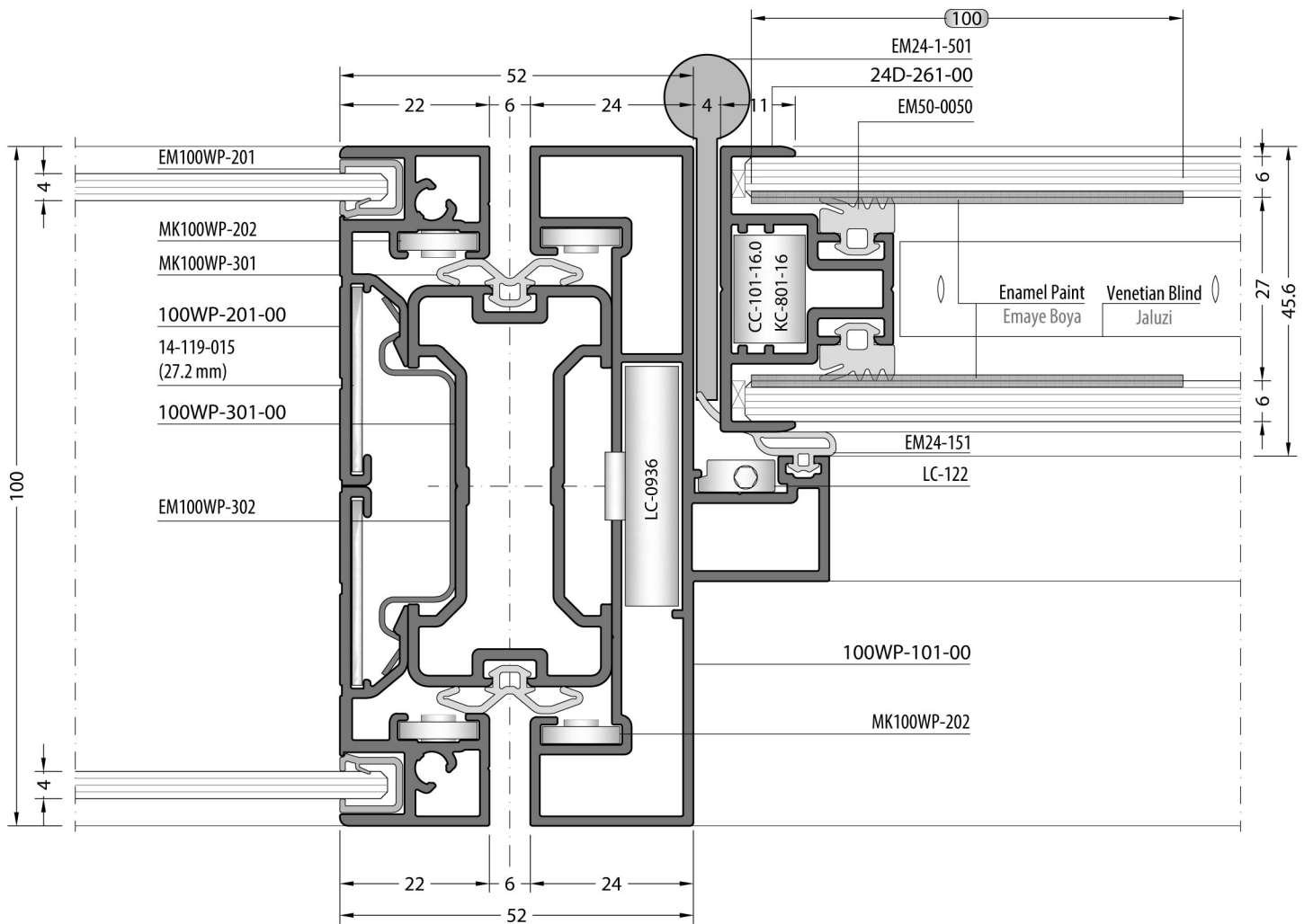
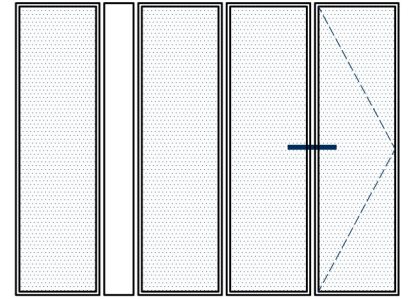

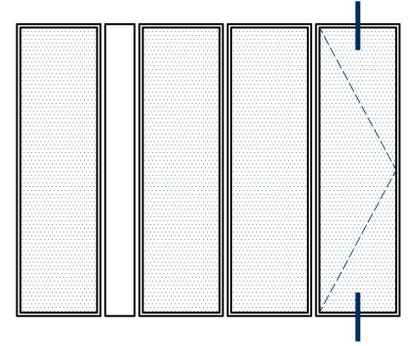
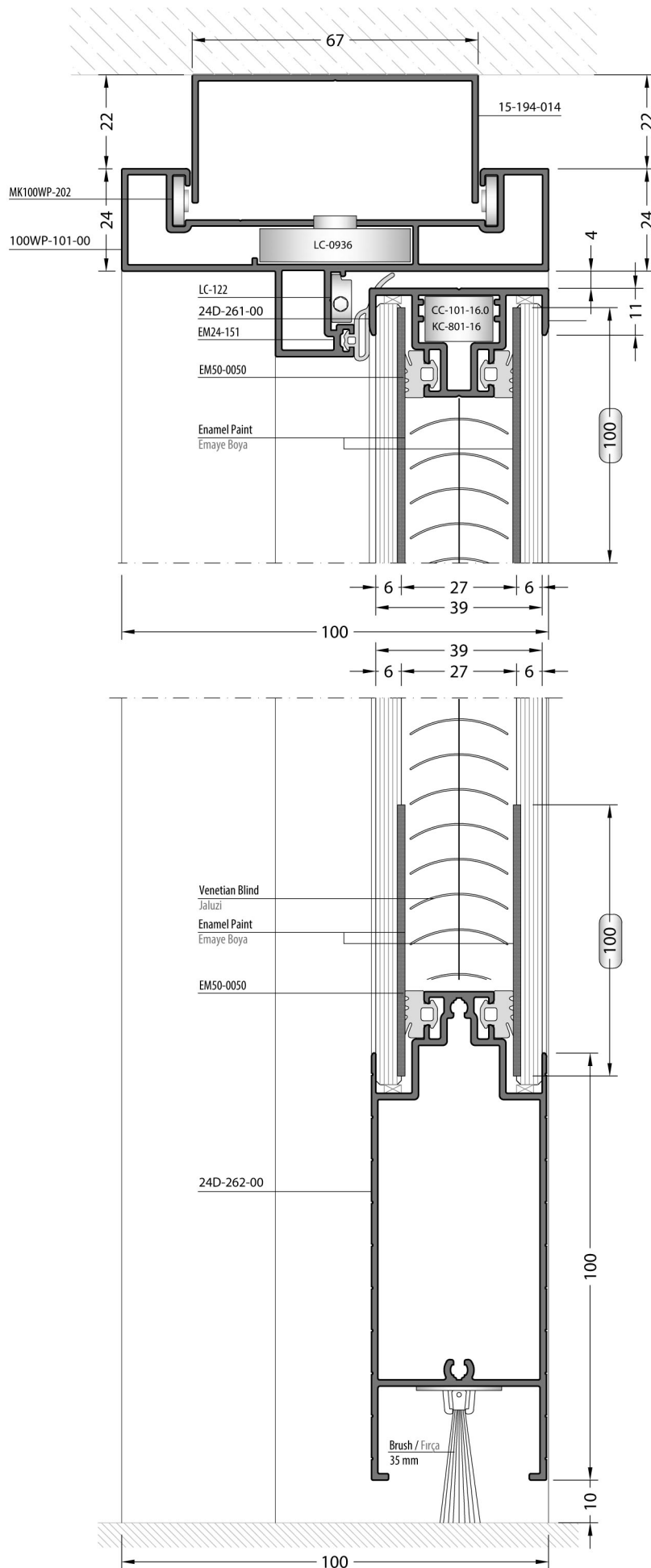

No scaled / Ölçeksiz

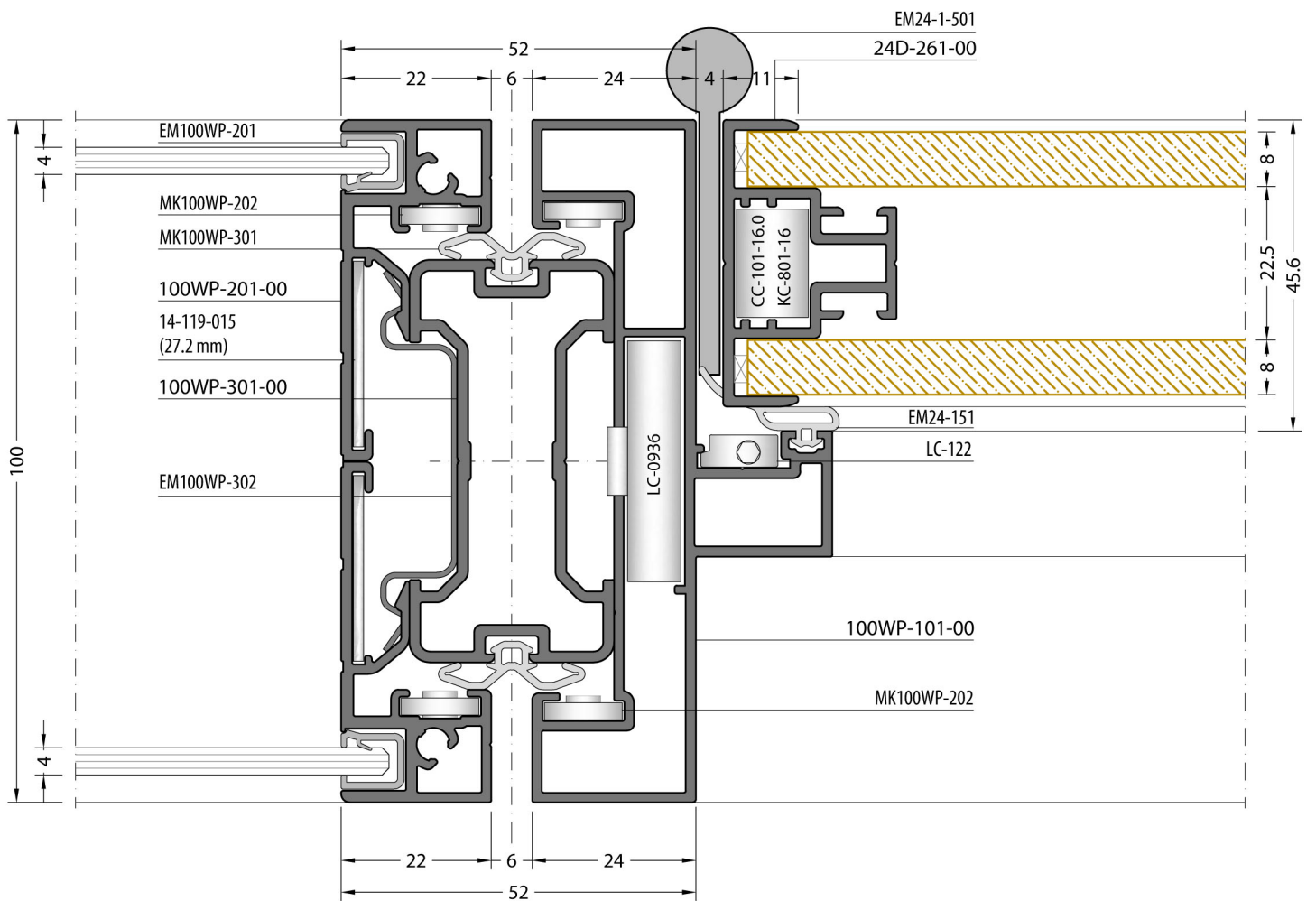
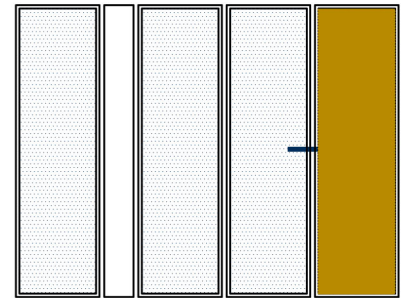

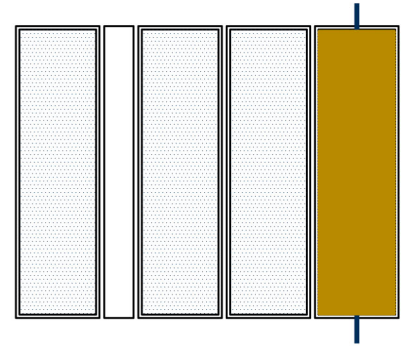
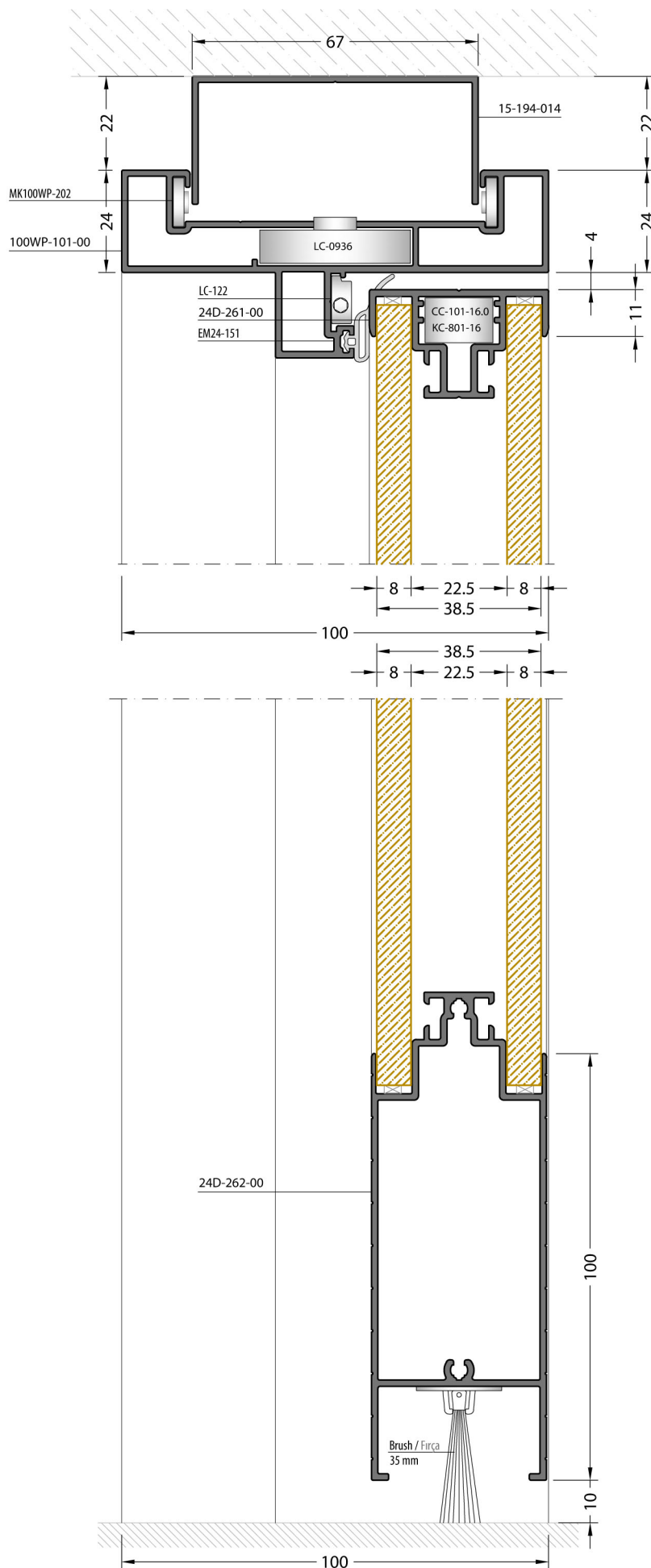

No scaled / Ölçeksiz

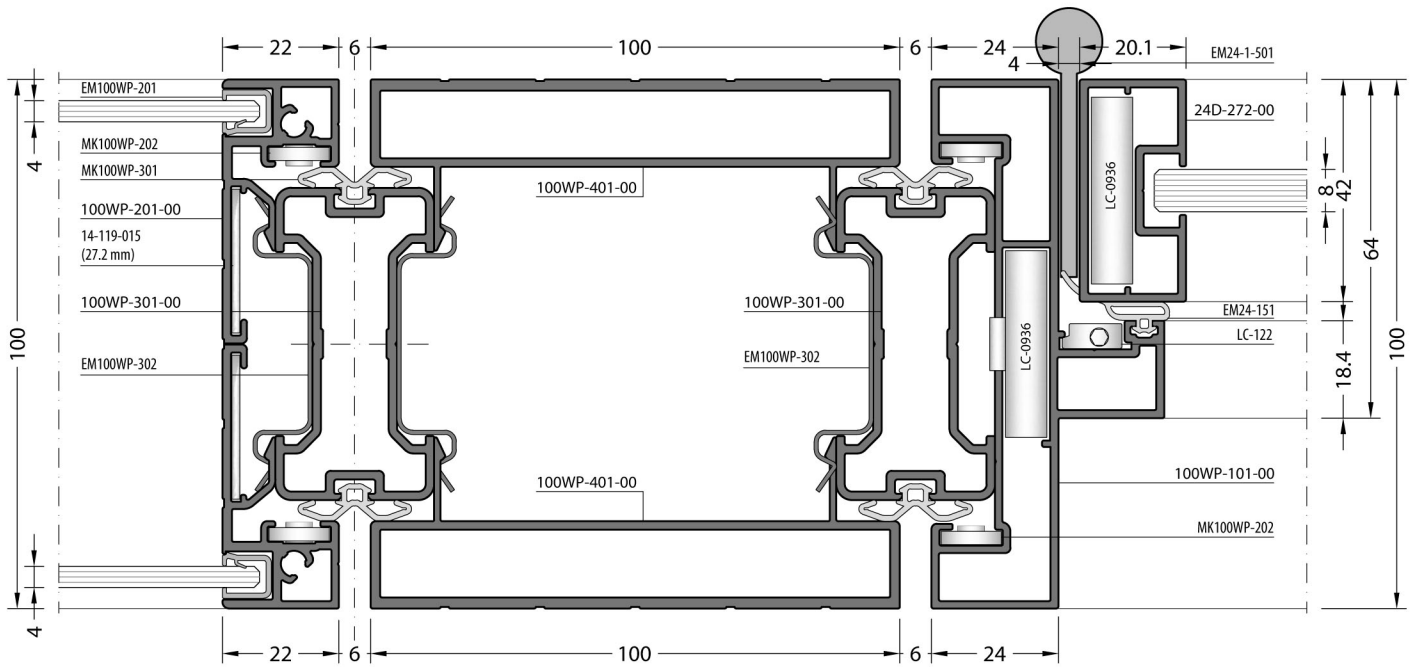
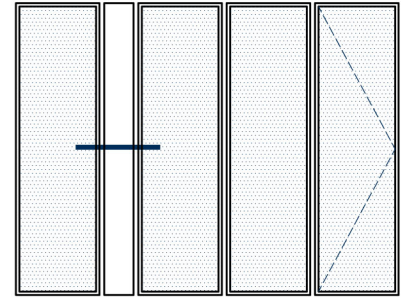

No scaled / Ölçeksiz

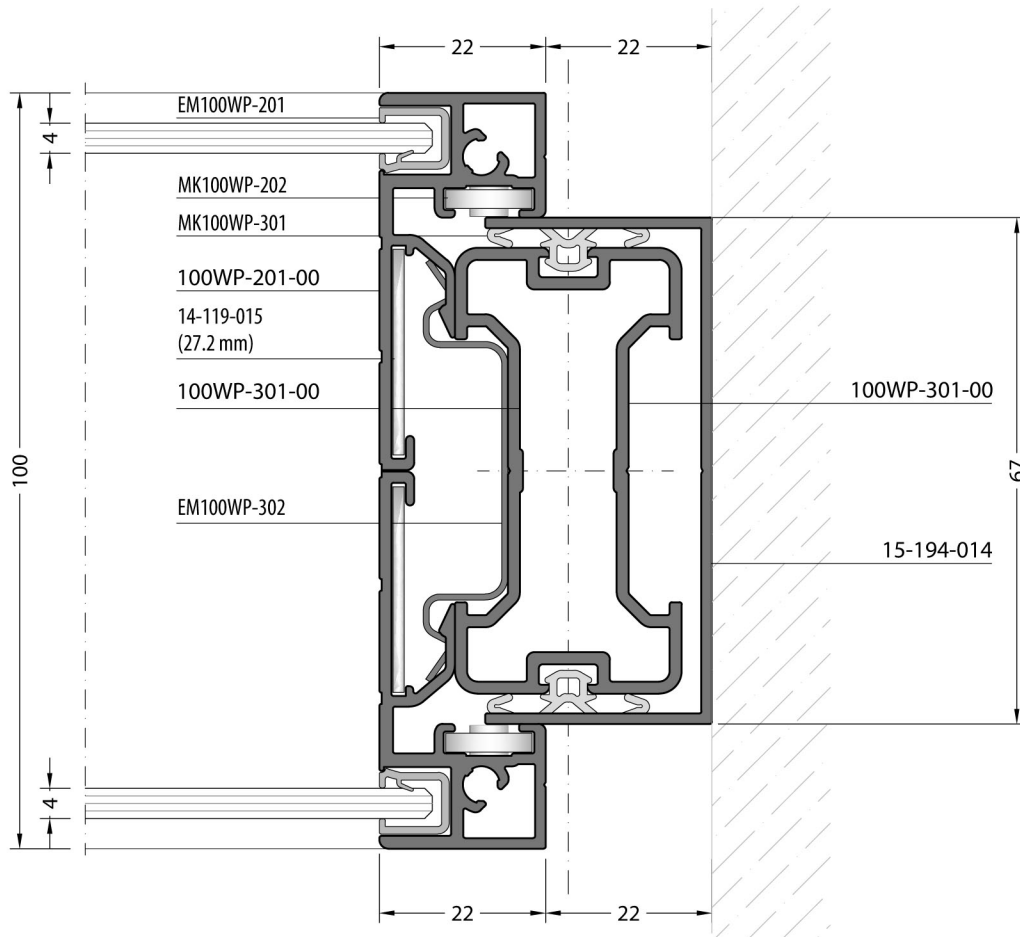
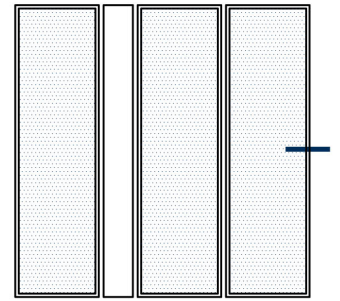

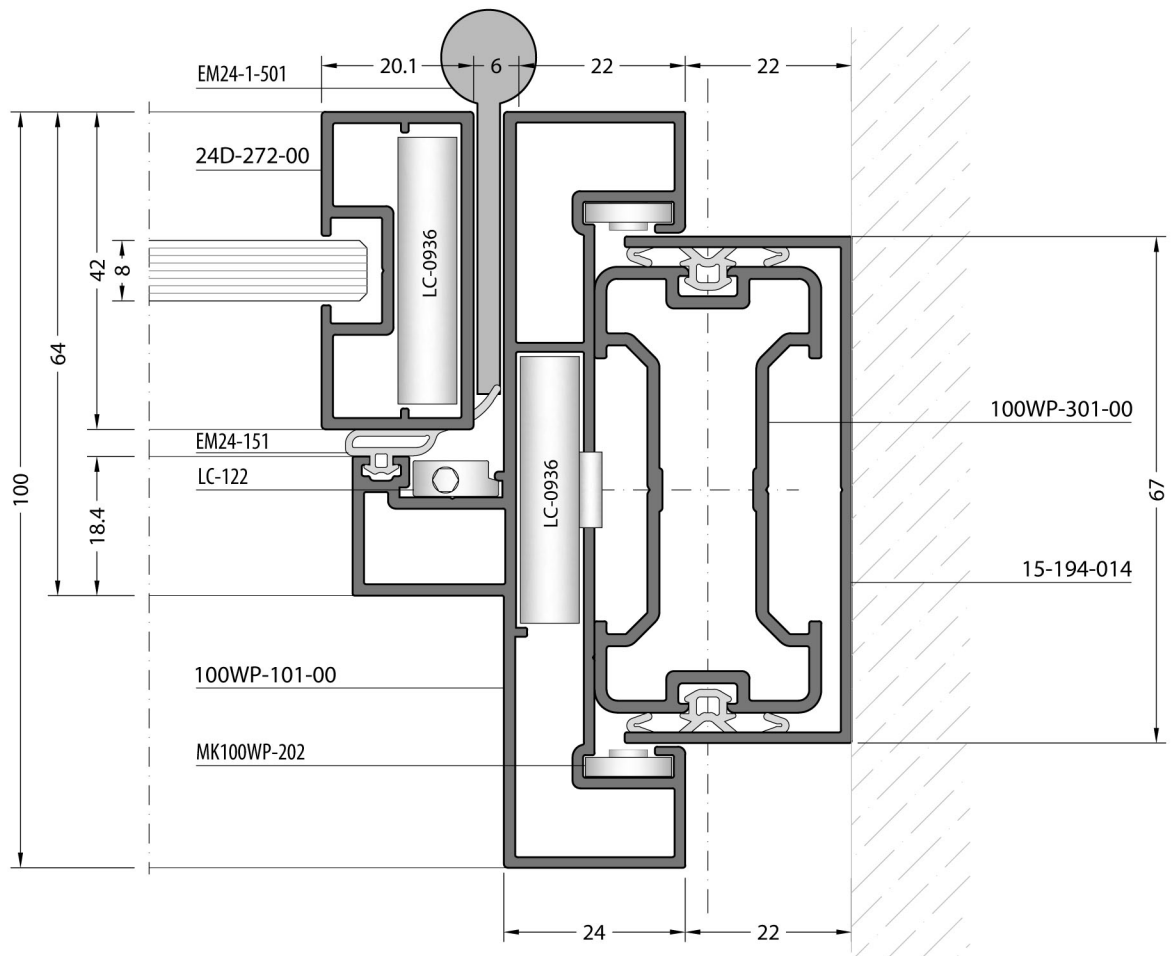
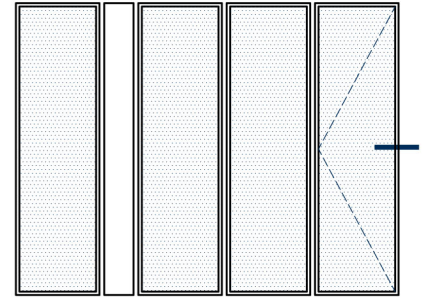

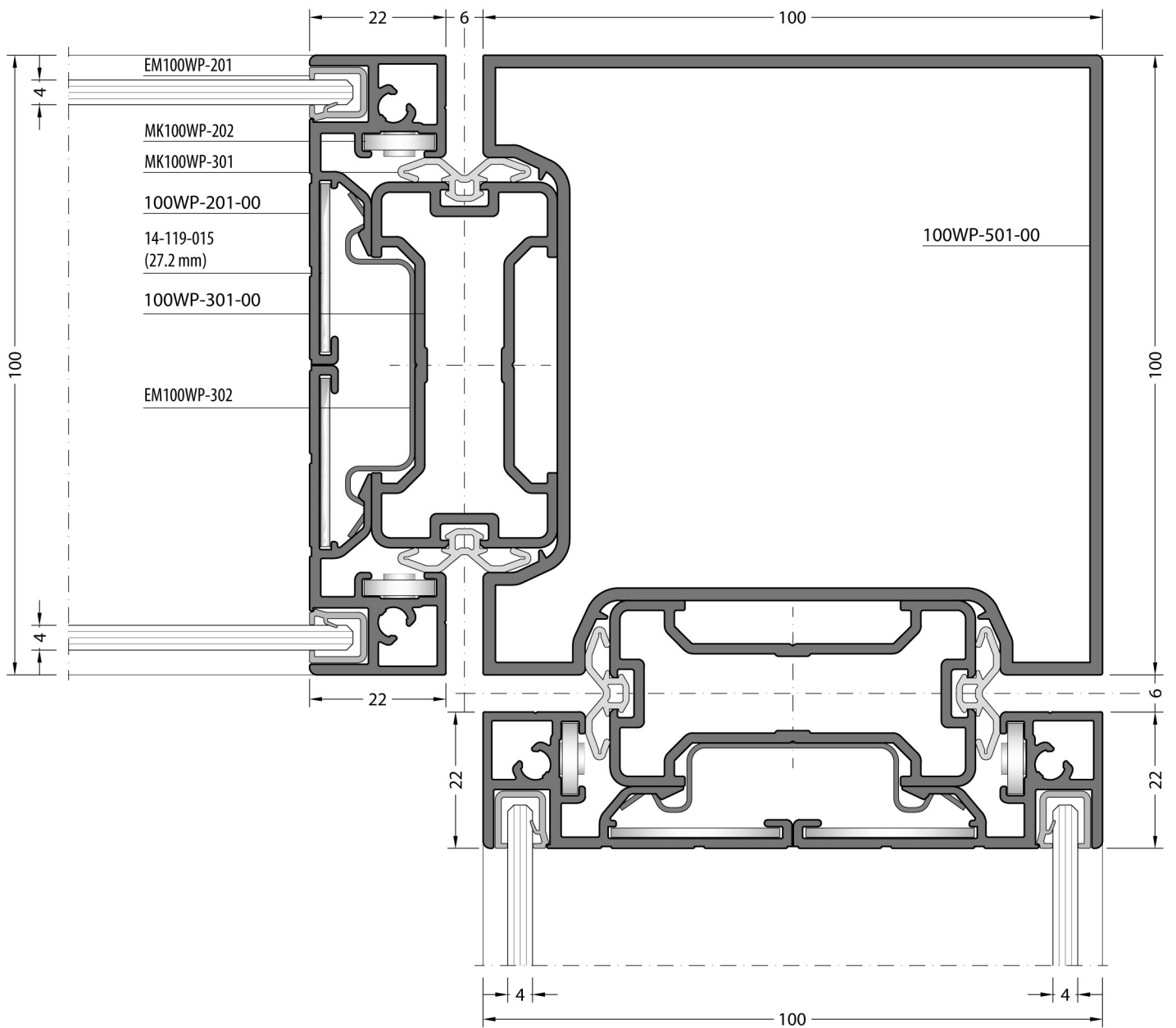
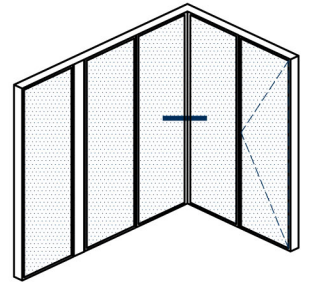

ACCESSORIES
AKSESUARLAR

ACCESSORIES / AKSESUARLAR

CODE / KOD	DRAWING / ÇİZİM	APPLICATION / UYGULAMA	DESCRIPTION / AÇIKLAMA
EM100WP-301			EPDM GASKET EPDM FİTİL
EM100WP-201			PVC PROFILE PVC PROFİL (3 Meter / Metre)
EM100WP-302			PANEL HOLDER PANEL TUTUCU
LC-0936			DIE-CAST CORNER JOINT PİMLİ BAĞLANTI
LC-122			CORNER JOINT KÖŞE BAĞLANTI
MK100WP-202			CORNER JOINT KÖŞE BAĞLANTI
14-119-015 (27.2 mm)			CORNER JOINT KÖŞE BAĞLANTI
CC-101-16.0			CORNER JOINT KÖŞE BAĞLANTI
KC-801-10.5			CORNER JOINT KÖŞE BAĞLANTI
KC-801-16.0			CORNER JOINT KÖŞE BAĞLANTI

